

mell

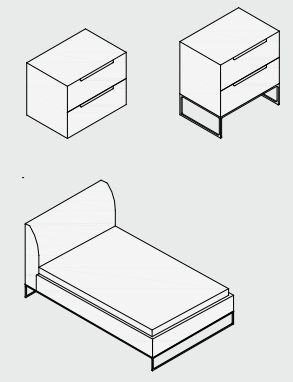

Specifications
Spezifikationen
Spécifications
Technische gegevens

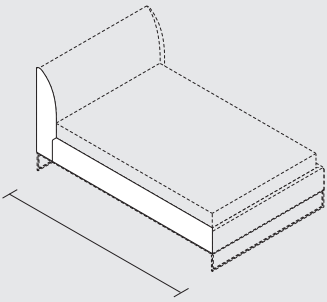
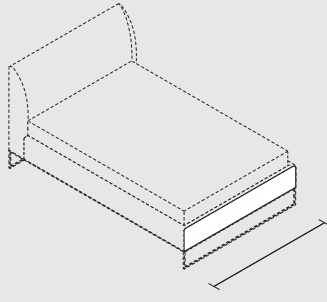
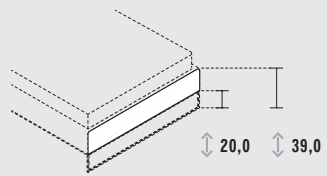
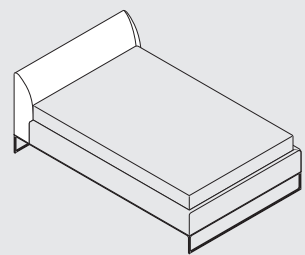
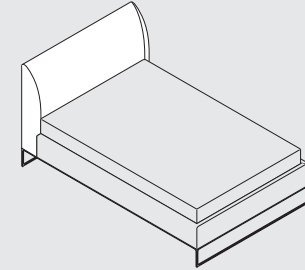
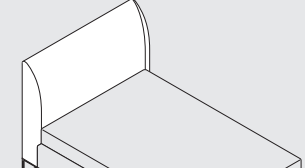

mell bed **mell Bett** Lit mell mell bed

Length Länge Longueur Lengte	Width Breite Largeur Breedte	Height Höhe Hauteur Hoogte	Headboards Kopfteile Têtières Hoofdeinden
 <p>Mattress length + 23,0 cm (incl. headboard) ↔ Matratzenlänge + 23,0 cm (inkl. Kopfteil) Longueur du matelas + 23,0 cm (incl. tête)ère) Matraslengte + 23,0 cm (incl. hoofdeinde)</p>	 <p>Mattress width + 13,0 cm ↔ Matratzenbreite + 13,0 cm Largeur du matelas + 13,0 cm Matrasbreedte + 13,0 cm</p>	 <p>Height of lower edge of base system approx. 20,5 cm Höhe Unterkante Liegsystem ca. 20,5 cm Hauteur bord inférieur du système de couchage env. 20,5 cm Hoogte onderste kant ligstysteem ong. 20,5 cm</p>	 <p>↕ 85,0</p>  <p>↕ 100,0</p>  <p>↕ 115,0</p> <p>Size from floor to top edge of headboard Maß von Fußboden bis Oberkante Kopfteil Dimension du sol au bord supérieur de la tête de lit Afstand van vloer tot bovenste kant hoofdeinde</p>

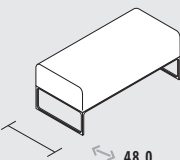
mell upholstered bench **mell Polsterbank** Banc capitonné mell mell gestoffeerde bedbank

 <p>↔ 48,0</p>	 <p>↔ 95,0</p>	 <p>↕ 43,0</p>	
---	---	---	--

Version bed and upholstered bench: in COR fabric, in COR leather, other fabrics and leathers possible **Ausführung Bett und Polsterbank: in COR Stoff, in COR Leder, andere Stoff- und Lederausführungen möglich**
 Finitions lit et banc : en tissu COR, en cuir COR, autres tissus et cuirs possibles **Uitvoering bed en gestoffeerde bank: van COR-stof, van COR-leder, andere stof- en lederuitvoeringen mogelijk**

Mattress lengths **Matratzenlängen** Longueurs de matelas Matraslengten: **200, 210 cm.**
 Mattress widths **Matratzenbreiten** Largeurs de matelas Matrasbreedten: **140, 160, 180, 200 cm.**

mell plinth **mell Sockel** Socle mell mell sokkel

Feet **Füße** Pieds Poten

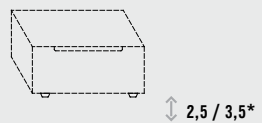

Skid frame **Kufengestell** Piètement à patins Slede-onderstel

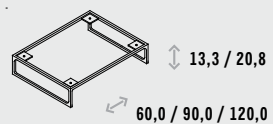

Skid frame **Kufengestell** Piètement à patins Slede-onderstel

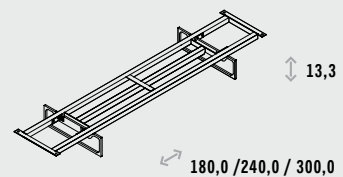

mell sideboards **mell Sideboards** Sideboards mell mell sideboards

Depth **Tiefe** Profondeur Diepte



Height **Höhe** Hauteurs Hoogte

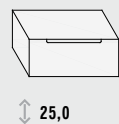

Drawers **Schubkästen** Tiroirs Laden

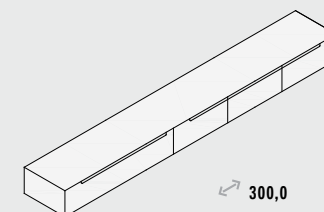
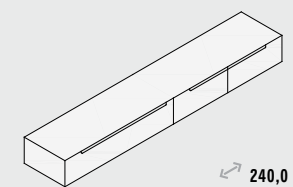
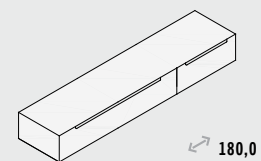
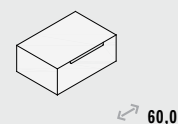

* For gliding door sideboard * **Bei Schiebetürensieboard** * Pour sideboard à portes coulissantes * Voor schuifdeurensieboard

Depth **Tiefe** Profondeur Diepte

Height **Höhe** Hauteur Hoogte

Drawers **Schubkästen** Tiroirs Laden

Doors **Türen** Portes Deuren



↔ 45,0

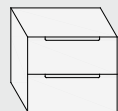

↕ 50,0



↔ 60,0

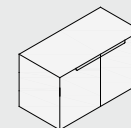

↔ 90,0

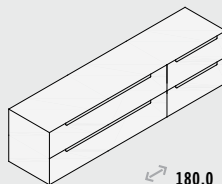

↔ 180,0

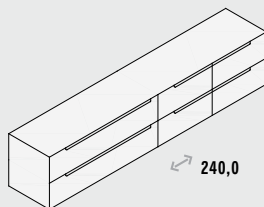

↔ 240,0

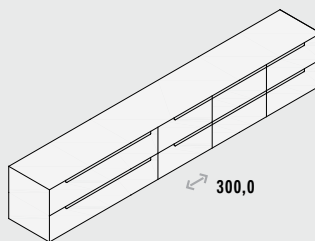

↔ 300,0

mell TV panel **mell TV Paneel** mell panneau TV mell TV Paneel

Thickness **Stärke** Épaisseur Dikte

Height **Höhe** Hauteur Hoogte

Widths **Breiten** Largeurs Breedten

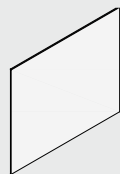

↕ 2,6

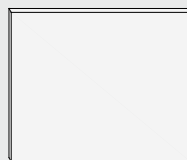

↕ 100,0



↔ 120,0

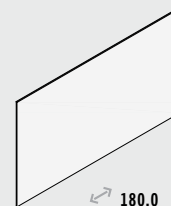

↔ 180,0

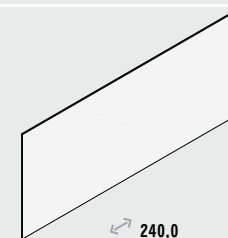

↔ 240,0

Depth **Tiefe** Profondeur Diepte

Height **Höhe** Hauteurs Hoogte

Gliding doors **Schiebetüren** Portes coulissantes Schuifdeuren

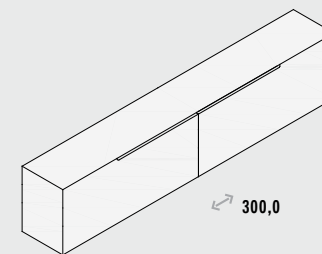
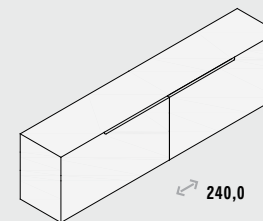
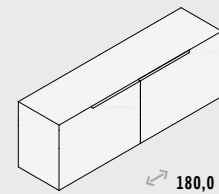
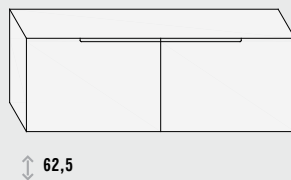
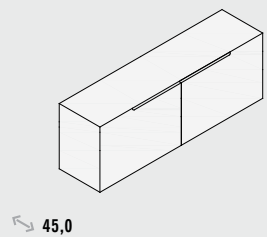

Depth/Height **Tiefe/Höhe** Prof/Ht Diepte/Hoogte

Drawers **Schubkästen** Tiroirs Laden







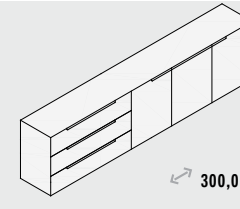
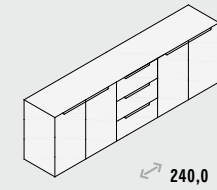
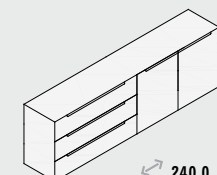
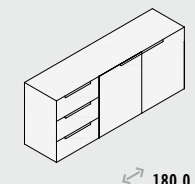
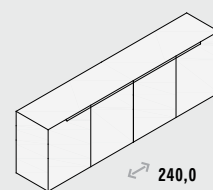
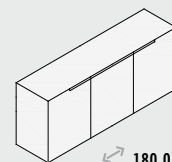
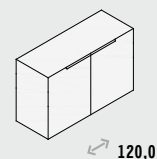
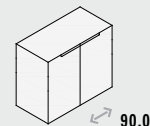
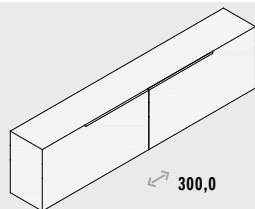
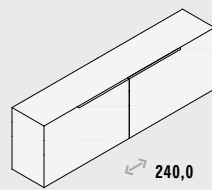
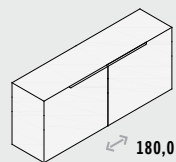
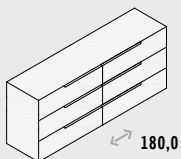
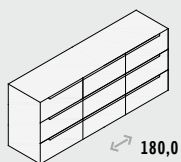
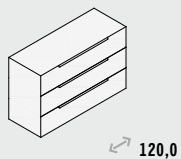
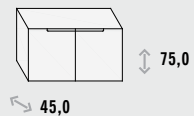

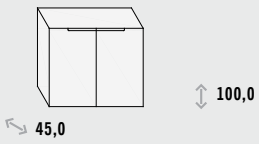
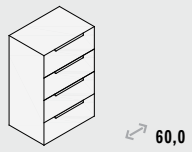
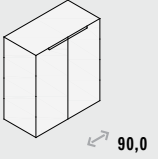
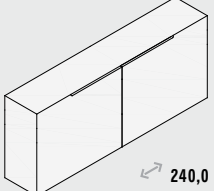
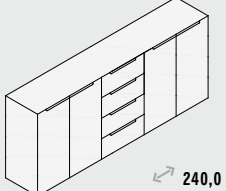
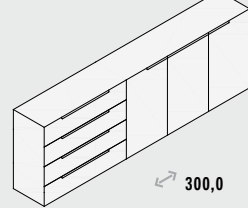
Sliding doors **Schiebetüren** Portes coul. Schuifdeuren

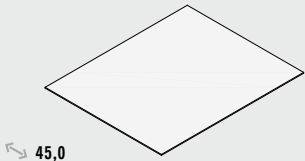

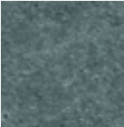
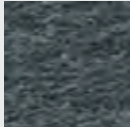
Doors **Türen** Portes Deuren

Combinations **Kombinationen** Combinaisons Kombinaties

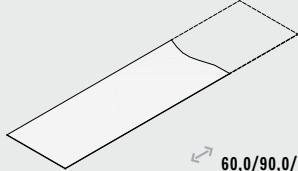

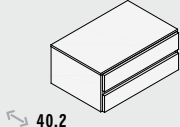

Depth/Height Tiefe/Höhe Prf/Ht Diepte/Hoogte	Drawers Schubkästen Tiroirs Laden	Sliding doors Schiebetüren Portes coul. Schuifdeuren	Doors/ Combinations Türen/ Kombinationen Portes/ Combinaisons Deuren/ Kombinaties	
 <p>45,0 100,0</p>	 <p>60,0</p>			
	 <p>90,0</p>		 <p>90,0</p>	 <p>90,0</p>
	 <p>120,0</p>		 <p>120,0</p>	
		 <p>180,0</p>		 <p>180,0</p>
		 <p>240,0</p>	 <p>240,0</p>	 <p>240,0</p>
		 <p>300,0</p>		 <p>300,0</p>

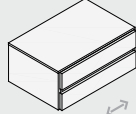
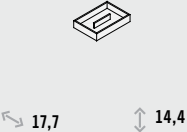
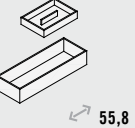
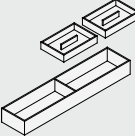
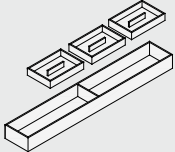
mell top closing panels mell Abdeckplatten Plateaux supérieurs mell mell afdekbladen				
Depth Tiefe Profondeur Diepte	Finish Ausführung Finition Uitvoering		Widths Breiten Largeurs Breedten	
 <p>↔ 45,0</p>	 <p>Lacquer* Lack* Laque* Lak*</p>	 <p>Concrete Beton Béton Betón</p>	 <p>Slate Schiefer Ardoise Leisteen</p>	
	 <p>Bend leather cognac Kernleder cognac Cuir sellier cognac Kernleer cognac</p>	 <p>Bend leather chocolate Kernleder schoko Cuir sellier chocolat Kernleer choco</p>	 <p>Bend leather black Kernleder schwarz Cuir sellier noir Kernleer zwart</p>	 <p>↔ 60,0/90,0/120,0/180,0/240,0/300,0</p>
	 <p>Rip oak natural Risseiche natur Chêne fissuré naturel Eikenhout naturel</p>	 <p>Rip oak silver-grey Risseiche silbergrau Chêne fissuré gris d'argent Eikenhout zilvergrijs</p>		

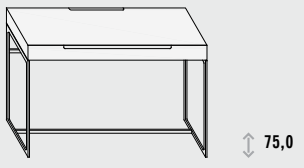

mell interiors mell Inneneinteilungen Aménagements intérieurs mell mell binnenindeling			
Depth Tiefe Profondeur Diepte	Heights Höhen Hauteurs Hoogten	Interior drawer Innenschubkasten Tiroir intérieur Binnenlade	
 <p>↔ 40,2</p>	 <p>↕ 25,7</p>	 <p>↔ 59,5</p>	<p>For gliding door sideboard Für Schiebetürensidoboard Pour sideboard à portes coulissantes Voor schuifdeurensideboard</p>
Depth/Height Tiefe/Höhe Prf/Ht Diepte/Hoogte	Drawer insert Schubkasteneinsatz Aménagement de tiroir Ladeninzet		
 <p>↔ 17,7 ↕ 14,4</p>	 <p>↔ 55,8</p>	 <p>↔ 81,8</p>	 <p>↔ 111,8</p>

* Alle interlücke matt and high gloss lacquers * **Alle interlücke Matt- und Hochglanzlacke** * Toutes les laques mates et brillantes interlücke * Alle matte en hoogglans interlücke lakken

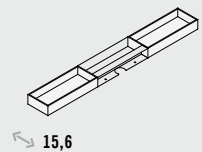

mell escratoire **mell Sekretär** Scriban mell mell secretaire

Depth Tiefe Profondeur Diepte	Heights Höhe Hauteur Hoogte	Width Breite Largeur Breedte
 <p>↔ 55,0</p>	 <p>↕ 75,0</p>	 <p>↔ 120,0</p> <p>Front with drawer Vorn mit Schubkasten A l'avant avec tiroir Voorzijde met lade</p> <p>Back with organizer compartment Hinten mit Organisationsfach A l'arrière avec compartiment de rangement Achterzijde met orga-indeling</p>

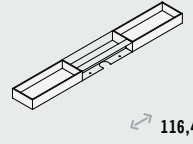
Organizer compartment on the back of the escratoire **Organisationsfach hinten im Sekretär** Compartiment de rangement à l'arrière du scriban Orga-indeling aan de achterzijde van de secretaire

Depth Tiefe Profondeur Diepte	Heights Höhen Hauteurs Hoogten	Width Breite Largeur Breedte
 <p>↔ 15,6</p>	 <p>↕ 6,3</p>	 <p>↔ 116,4</p> <p>Incl. power and USB connector Inkl. Strom- und USB-Anschluss Y inclus port d'alimentation et port USB Incl. stroom- en USB-aansluiting</p>

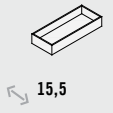
Divider box for organizer compartment **Einteilungsbox für Organisationsfach** Boîte pour compartiment de rangement Box voor orga-indeling

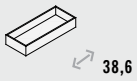
Depth Tiefe Profondeur Diepte	Heights Höhen Hauteurs Hoogten	Width Breite Largeur Breedte
 <p>↔ 15,5</p>	 <p>↕ 6,3</p>	 <p>↔ 38,6</p>

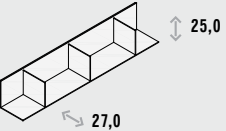
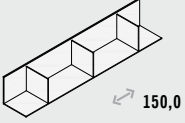
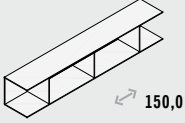
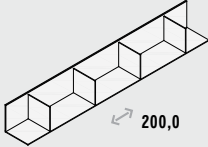
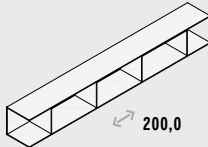
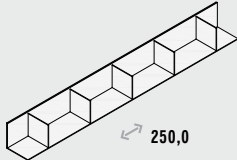
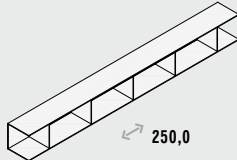
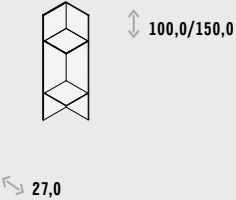
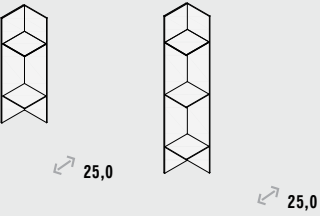
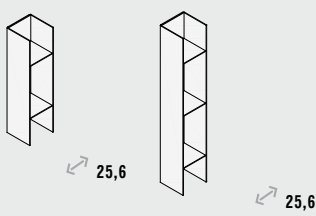
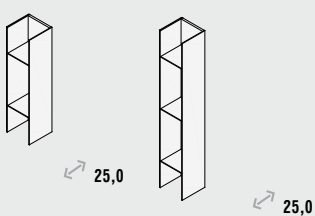
mell wall shelving horizontal and vertical mell Wandregale horizontal und vertikal Rayonnage mell horizontal et vertical mell wandrek horizontaal en verticaal			
Depth/Height Tiefe/Höhe Prf/Ht Diepte/Hoogte	L-shape L-Form Forme L L-vorm	U-shape U-Form Forme U U-vorm	
			
			
			
Depth/Height Tiefe/Höhe Prf/Ht Diepte/Hoogte	L-shape L-Form Forme L L-vorm	U-shape U-Form Forme U U-vorm	U-shape turned U-Form gedreht Forme U tournée U-vorm gedraaid
			
Utensil insert for wall shelving Utensilieneinsatz für Wandregal Aménagement accessoires pour rayonnage Accessorie-inzet voor wandrek			
Depth Tiefe Profondeur Diepte	Heights Höhen Hauteurs Hoogten	Width Breite Largeur Breedte	
