

FILIGREE

tado

tado

Shelf

Sideboard

Room divider

Design: kaschkasch



Collection description

Description..... 4
 Accessories..... 5
 Colors and materials..... 8
 Planning and dimension overview..... 13



The concept

tado is stage and design object at the same time. Because the fine frames offer individual leeway for open spaces and volumes. For staging beautiful things, for modules, boxes and trays. Lightness and cosiness are not mutually exclusive, but form a perfect combination thanks to well thought-out design.

Design: kaschkasch





The subtle difference

tado's design is well thought out down to the last detail. A skilful play of shapes with different profile cross-sections and visible edges. The horizontal profiles, which are only 1.5 x 1.5 cm in size, play a supporting role. Together with visible shelf and front edging, real front joints, low front panels and high plinth profiles an extraordinarily exciting picture is created.

Space for individual design with open space and volumes is provided by shelves, modules, boxes and so on, together with elegant Colors and materials.

tado - a homely, elegant shelf that is unrivalled in terms of filigree and stability.

Behind the side profiles the shelf edges are not visible. Top/middle 2.35 cm high, bottom 4.35 cm high.



The visible shelf edges are formally taken up by the protruding fronts. Thus, the repetition of the material thickness of 0.8 cm ensures visual calmness.



Closed plinths - instead of visible adjustable legs - complete the homely impression. Deliberately higher plinth profiles convey the slightly floating character and stability at the same time. Front 3.5 cm high, side 4.35 cm high.



5 Raster high shelves are open at the top for greater lightness. At the front, the upper metal profiles are kept higher than the middle ones for the optical finish. Front and sides 2.35 cm high.



Shelves and boxes in matt lacquer and grey glass provide the stage for individual play with Colors and materials.

Display cabinet shelves protect selected books and magazines. Opened upwards, they attract attention to fine candles, vessels or vases.

With their raised edges, trays conceal things that should not be visible at first glance.

Back panels create the presentation platform for beautiful things; angled shelves with support strip provide space for cherished books, trays and more.

Always different. Therefore, all accessory elements can be moved and added later.



Closed modules are available as:

- Drawer module with one low and one high drawer, width in cm: 100
- Drawer module with one low drawer, width in cm: 100
- Flap module, width in cm: 100
- Hinged door module, width in cm: 35



The genuine horizontal joints in drawers, flaps and hinged doors create an even shadow appearance. To achieve this, the individual panels are elaborately attached to support plates.

For safety reasons, modules with drawers and flaps can be planned from below for the first and second compartment.

Accessories

Sideboards have top shelves in soft matt lacquer, transparent grey glass or the precious stones Grigio carnico patinato, Graphite brown patinato, Breccia imperial satin, Tropical storm sanded, Arabescato corchia polished or Taj mahal satin. Alternatively, 35 and 100 cm wide shelves can be planned.

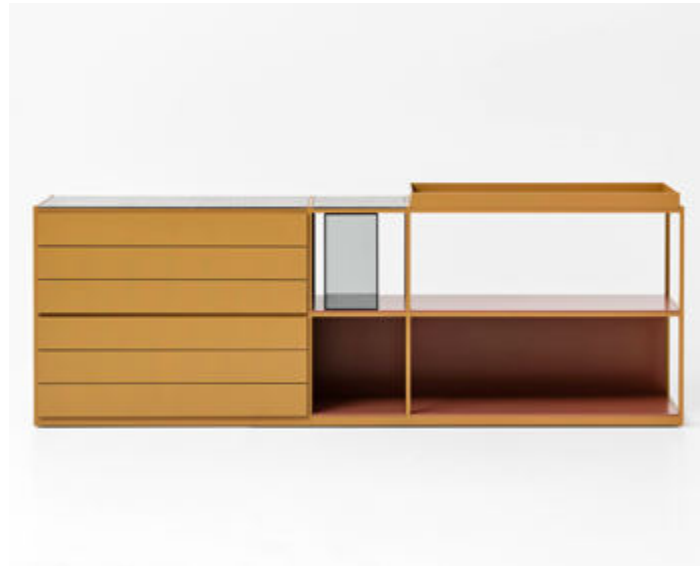

Thanks to the fine vertical profiles made of solid aluminium, no visually disturbing cover caps are required at the top.



Accessories

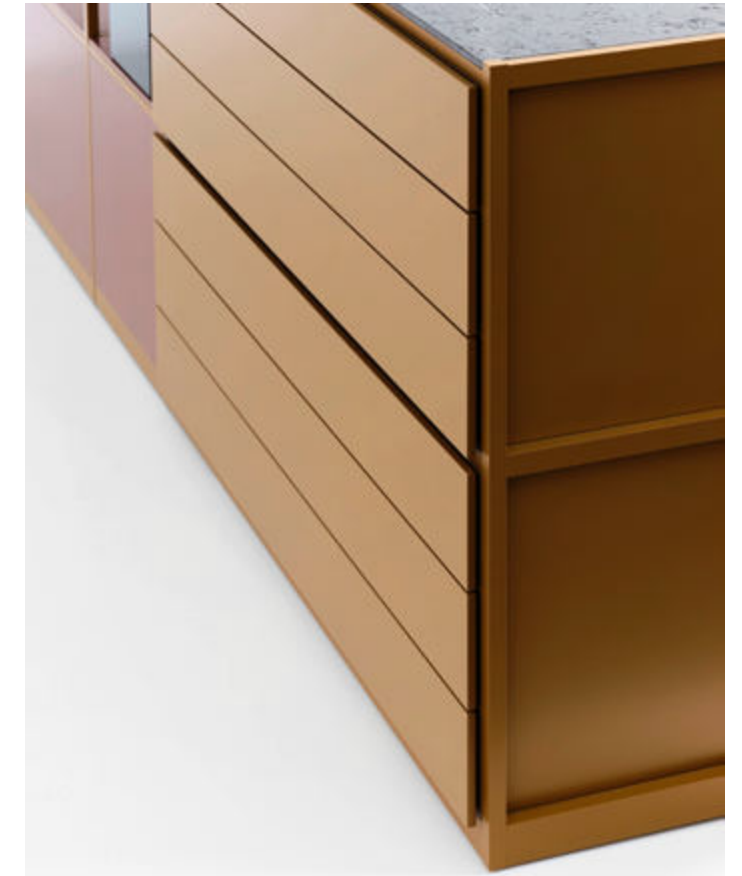
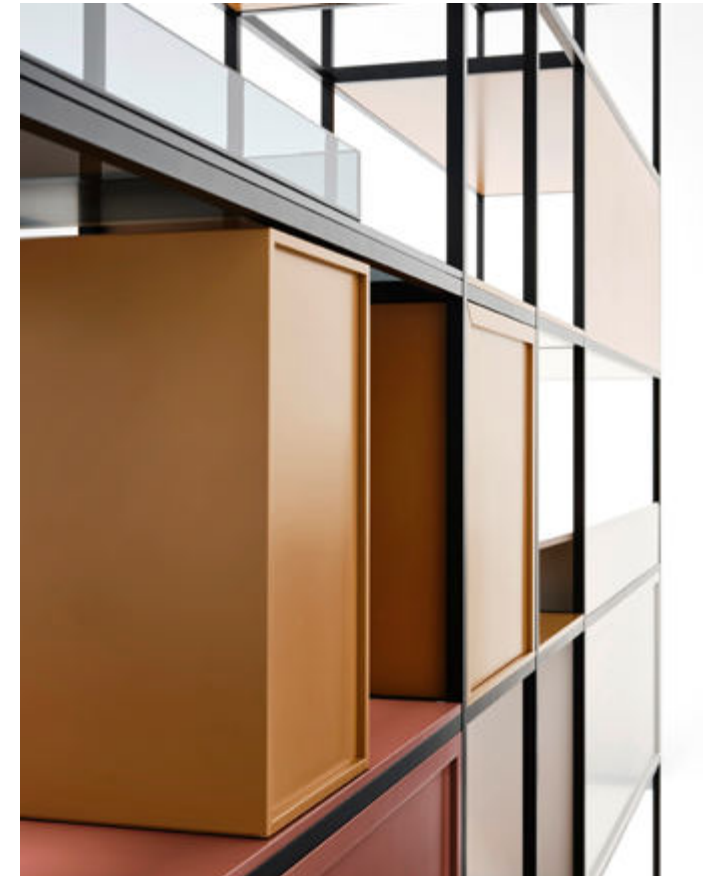

The surrounding grooved back panels of the modules and boxes are lacquered as standard and are suitable as room divider back panels.

On request, the modules can be supplied with room divider back panels in front appearance.



Room divider

Laterally mounted to the wall - 81.8, 159.2 and 197.9 cm high:

- Total width ≤ 204.8 cm no surcharge for room divider.
- Total width > 204.8 cm for add-on shelves order the surcharge for room dividers (= weight plates + metal plates with adjustable legs).

Freestanding room dividers:

- Height 81.8 cm for basic and add-on shelves order the surcharge for room dividers (= weight plates + metal plates with adjustable feet).
- Height 159.2 and 197.9 cm for basic and add-on shelves, it is necessary to order the surcharge for room dividers (= material for floor fixing). 159.2 and 197.9 cm high shelves must be mounted in to the floor for safety reasons.

Colors and materials

The elegant tone-in-tone combination with black anodised metal profiles and transparent grey glass emphasises the filigree appearance. In addition, modules and angled shelves in matt lacquer elephant.

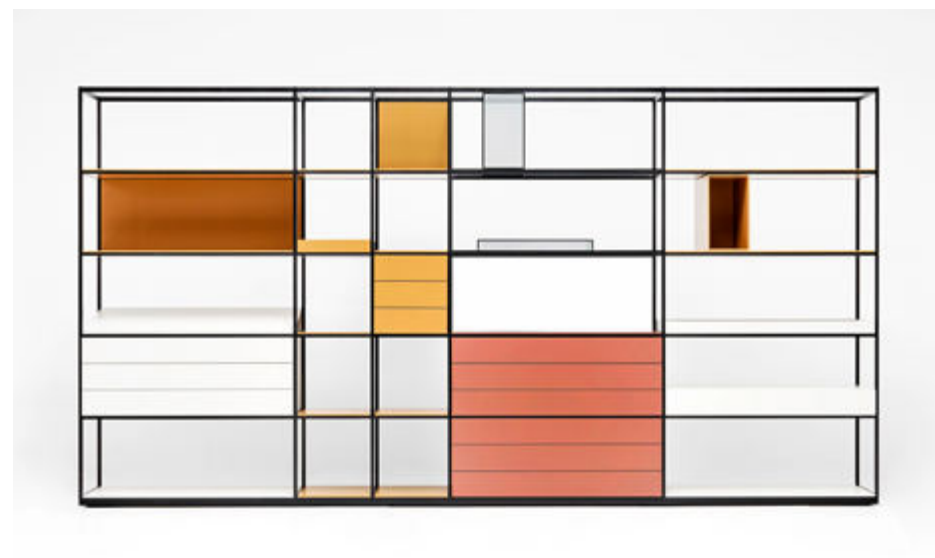

Light Colors for the accessories and dark anodising for the metal profiles perfectly emphasise the well thought-out design with visible edges and different profile cross-sections.

Colors and materials

Monochrome Colors stand for elegance and cosiness. For this purpose, the Colors from the attractive interlücke colour system are matched with metal frames in a slightly darker colour from the colour fans of the manufacturers NCS, Sikkens and RAL. Here modules and shelves in mallow the monochrome metal frame in NCS S 6030 Y90R - for a masterfully subtle light-dark interplay of Colors. For colour matching see price list page 2.



Metal profiles and modules are kept in the same colour masala. Mallow, Graphite brown patinato and grey glass set subtle accents.

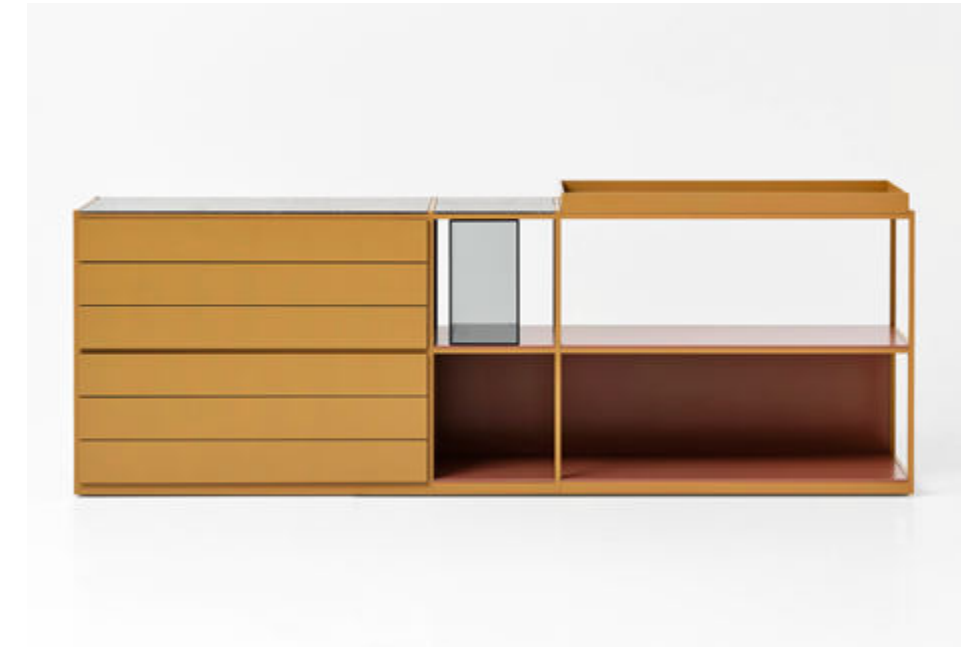

tado

Colors and materials

Monochrome matt lacquers for basic and add-on shelves with corresponding matt lacquers for accessories

Monochrome Colour	Matt lacquers
Sikkens ON.00.83	M03 snow-white
RAL 000 70 00	M14 platinum
NCS S 6502 B	M29 fog
RAL 000 20 00	M21 anthracite

Sikkens Q0.10.30	M80 laguna
NCS S 8005 B80G	M81 bahia
Sikkens S0.10.20	M82 atlantic
NCS S 8505 R80B	M83 navy

RAL 075 70 10	M08 greige
NCS S 4502 Y	M36 mastic
RAL 100 40 05	M37 manor
NCS S 8010 G70Y	M38 capparisi
RAL 080 30 26	M39 cardamom
RAL 070 40 40	M40 masala

Monochrome Colour	Matt lacquers
Sikkens G4.05.81	M02 crystal-white
RAL 085 80 10	M06 alabaster
Sikkens F6.05.50	M23 shell
RAL 000 45 00	M24 flint-grey
Sikkens F6.03.20	M16 elephant

NCS 3020 Y70R	M49 rose quartz
RAL 040 40 30	M44 guava
NCS S 6030 Y90R	M42 mallow
NCS 8010 R10B	M41 burgundy

Planning and dimension overview

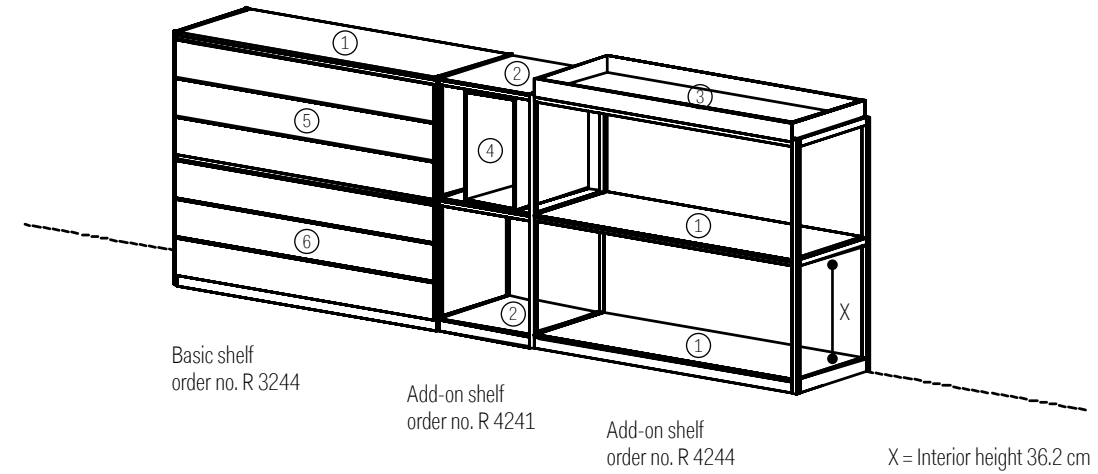

1. Shelf order no. R 0544 / R 0344 (Glass not for plinth)
2. Shelf order no. R 0541 / R 0341 (Glass not for plinth)
3. Tray order no. R 6714
4. Box order no. R 6811 / R 6911
5. Module with two drawers order no. R 6334
6. Module with flap order no. R 6634

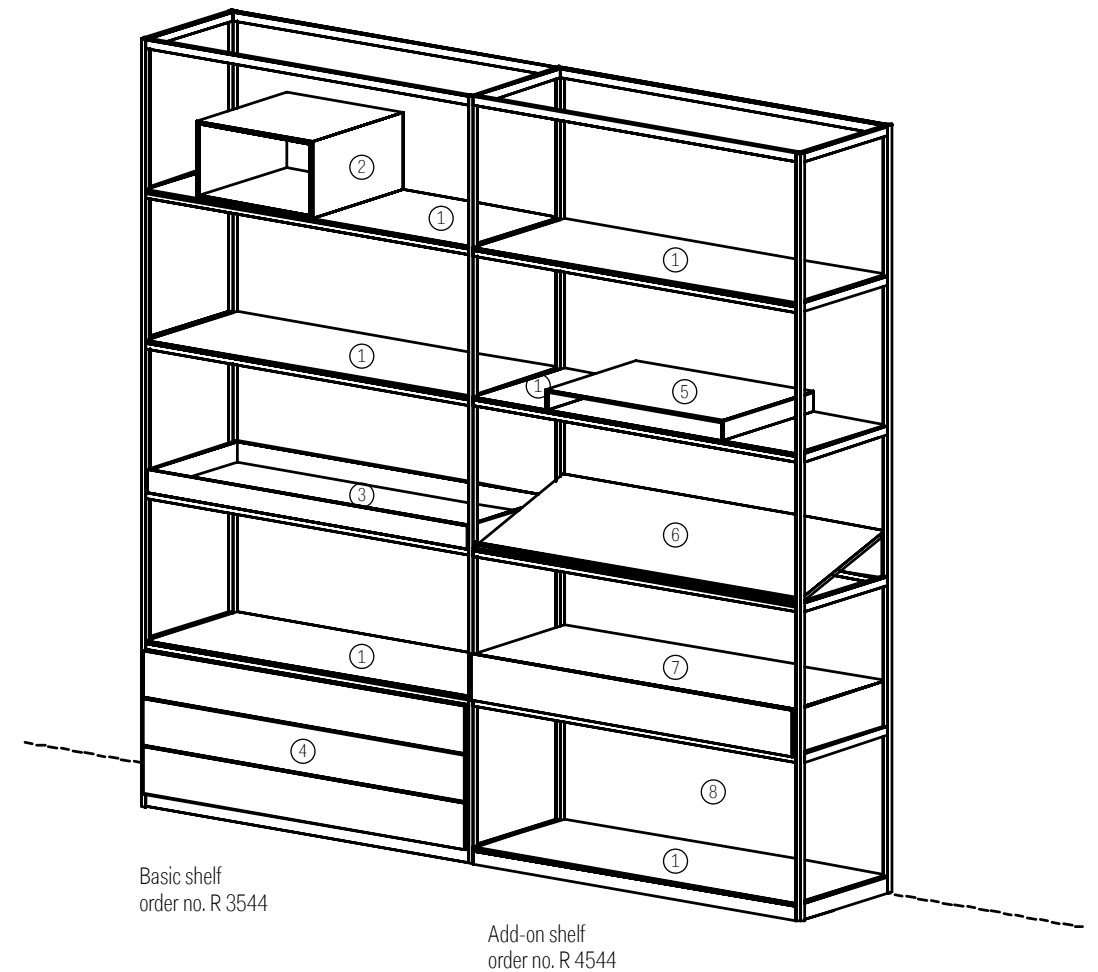

1. Shelf order no. R 0544 / R 0344 (Glass not for plinth)
2. Box order no. R 6811 / R 6911 (Glass not for plinth)
3. Tray order no. R 6714
4. Module with flap order no. R 6634
5. Display cabinet shelf order no. R 6902
6. Shelf angled order no. R 6724
7. Module with one drawer order no. R 6314
8. Back panel order no. R 7014